

# Mother's Day Pintofest

## English Equitation (Open/Pinto Youth/Amateur)

Show Date: 05-10-2015

W W W . H o r s e S h o w P a t t e r n s . c o m

W W W . H o r s e S h o w P a t t e r n s . c o m

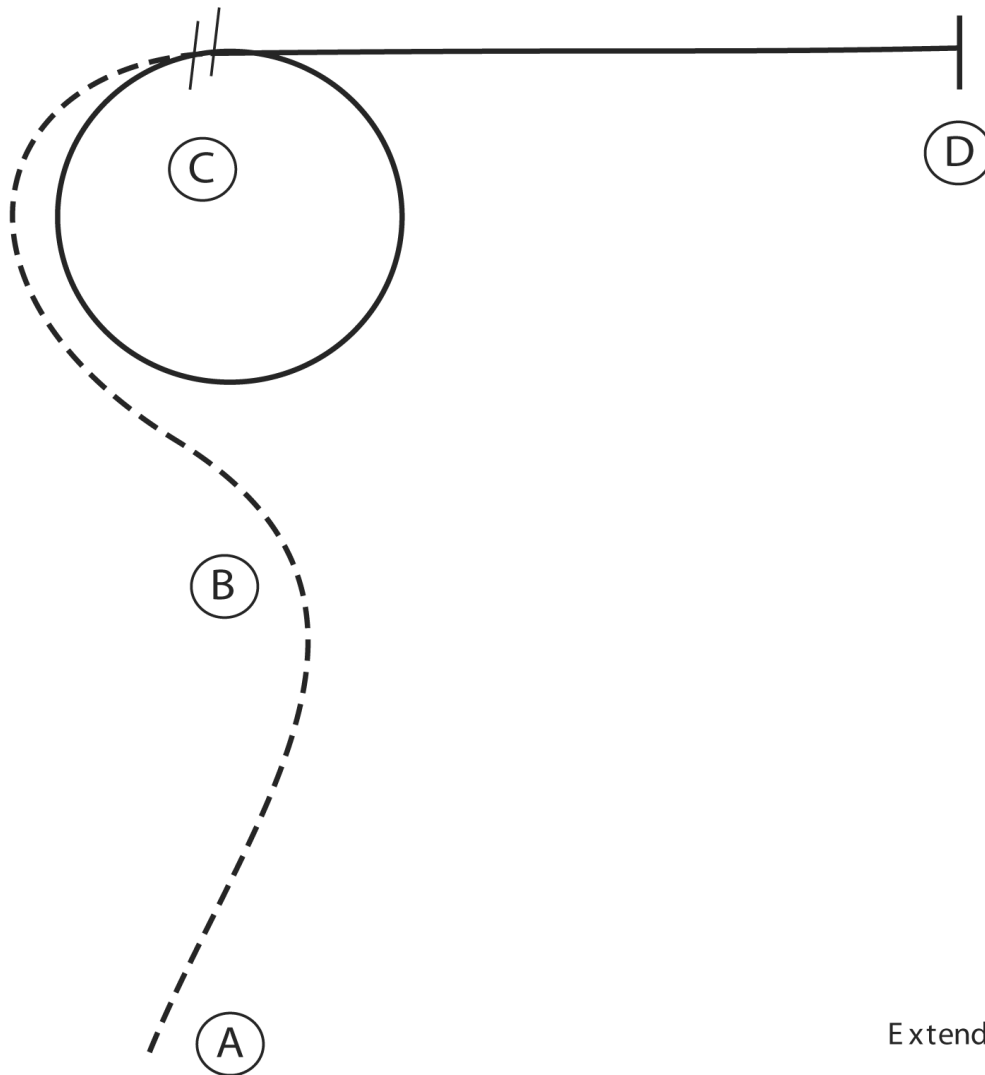

1. Posting trot A to B on the right diagonal
2. Change diagonals at B and continue to C
3. At C canter a circle to the right on the right lead
4. At C perform a lead change and continue to D
5. Stop at D

Walk	.....
Trot	- - - - -
Extended Trot	- - - - -
Canter	—————
Leg Yield	
Lead Change	↘ ↙
Back	←←←←← ←←←←←
Marker	(B)
Sidepass	←←←←←

[HSE/2-15]

Pattern Provided by:

*HDPtHA*

# Mother's Day Pintofest

## English Equitation Walk Trot (Non Pro/Novice)

Show Date: 05-10-2015

w w w . H o r s e S h o w P a t t e r n s . c o m

w w w . H o r s e S h o w P a t t e r n s . c o m

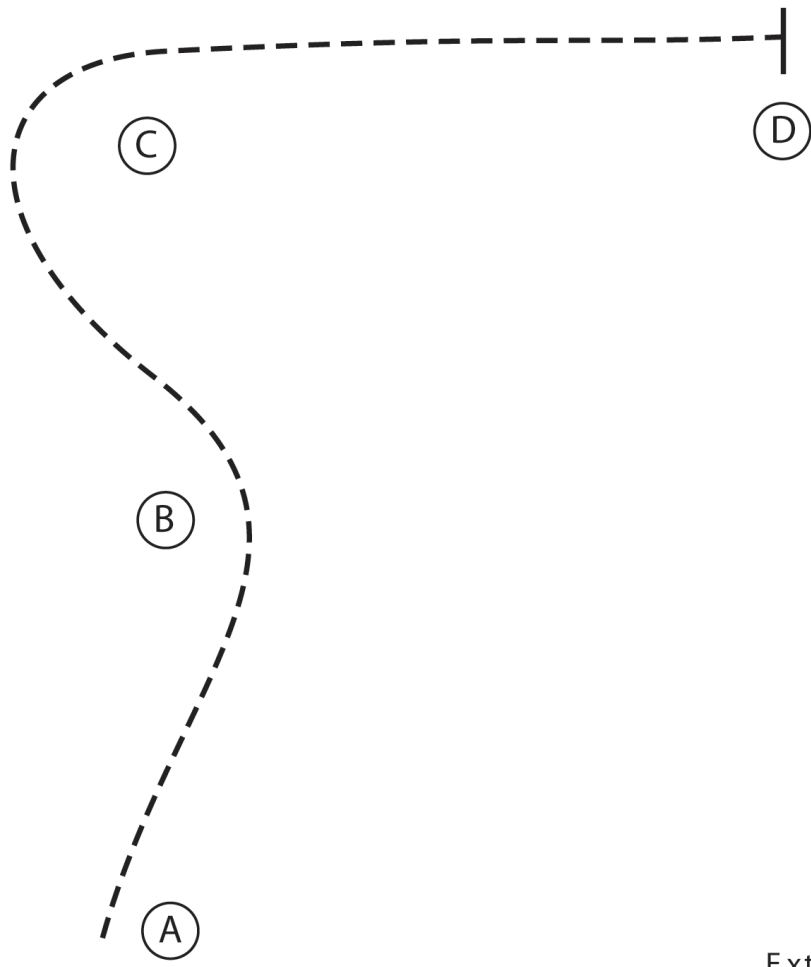

1. Posting trot A to B and B to and around C showing proper changes of diagonal
2. At C sitting trot to D
3. Stop at D

Walk	.....
Trot	-----
Extended Trot	-----
Canter	—————
Leg Yield	
Lead Change	↘
Back	←←←←←
Marker	(B)
Sidepass	←←←←←

[HSE/WT-6]

Pattern Provided by:

*HDPtHA*

# Mother's Day Pintofest

## English Showmanship (Pinto Youth/Amateur)

Show Date: 05-10-2015

w w w . H o r s e S h o w P a t t e r n s . c o m

w w w . H o r s e S h o w P a t t e r n s . c o m

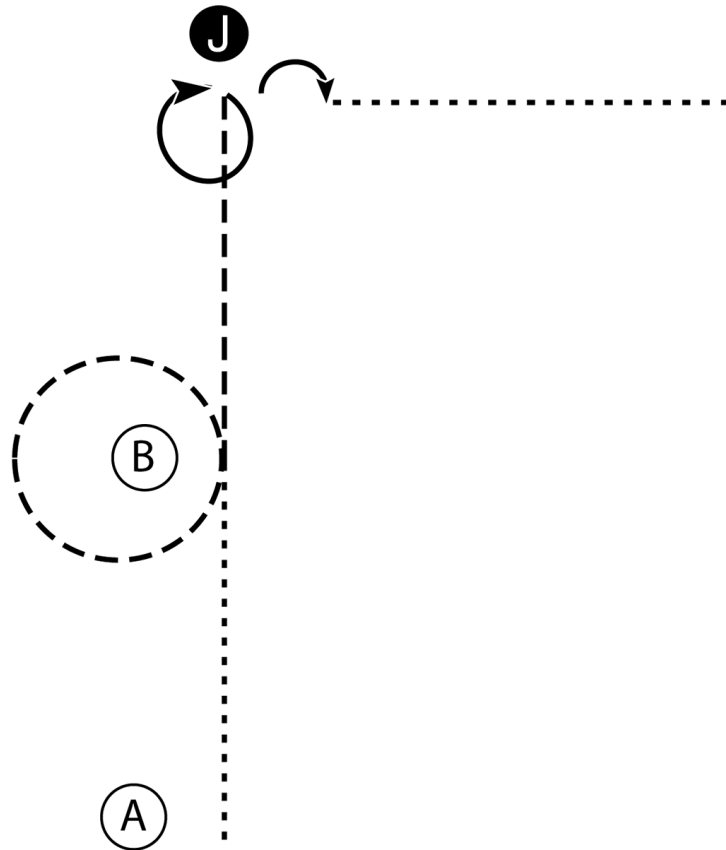

1. Walk from A to B.
2. At B trot. Trot a circle around B and continue to the Judge.
3. Stop and perform a 360 degree turn. Set up for inspection.
4. When dismissed perform a 90 degree turn.
5. Walk straight away from the Judge.

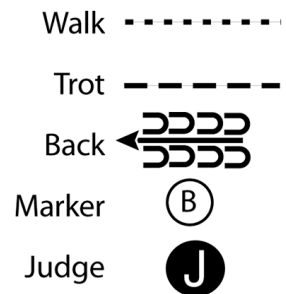

[S/2-8]

Pattern Provided by:

*HDPtHA*

# Mother's Day Pintofest

## Open Showmanship (All ages)

Show Date: 05-10-2015

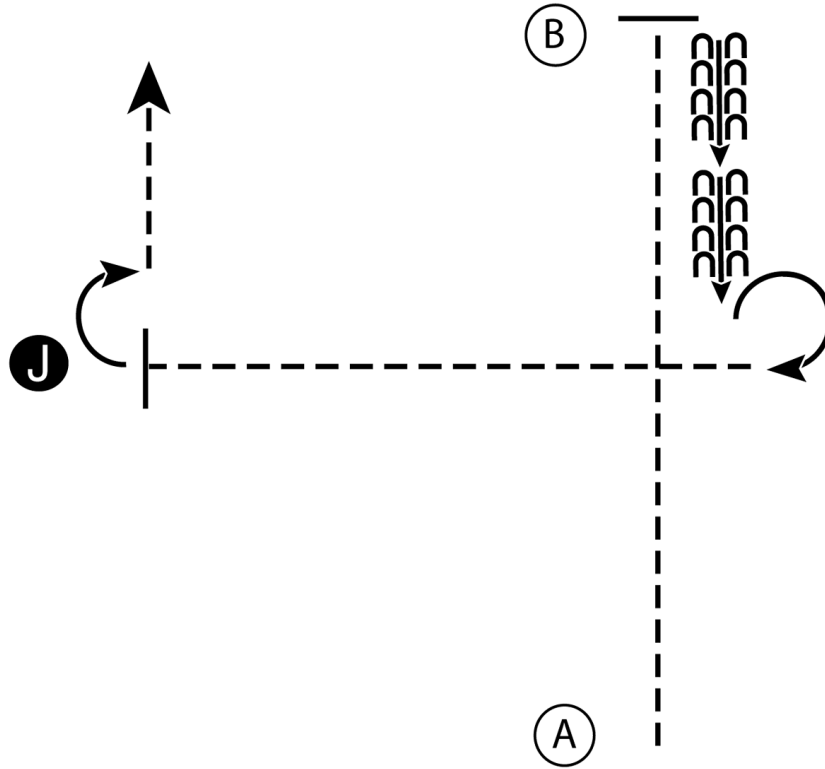

1. Trot A to B
2. Stop at B and back halfway to A
3. Stop and perform a 270 degree turn
4. Trot to judge and set up for inspection
5. When dismissed perform a 90 degree turn and trot away from judge

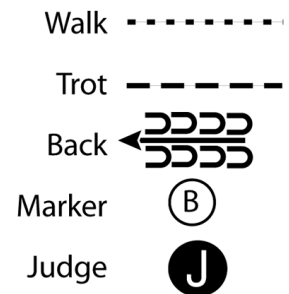

[S/2-3]

Pattern Provided by:

*HDPtHA*

# Mother's Day Pintofest

## Western Showmanship Pinto (Pinto Youth/ Amateur)

Show Date: 05-10-2015

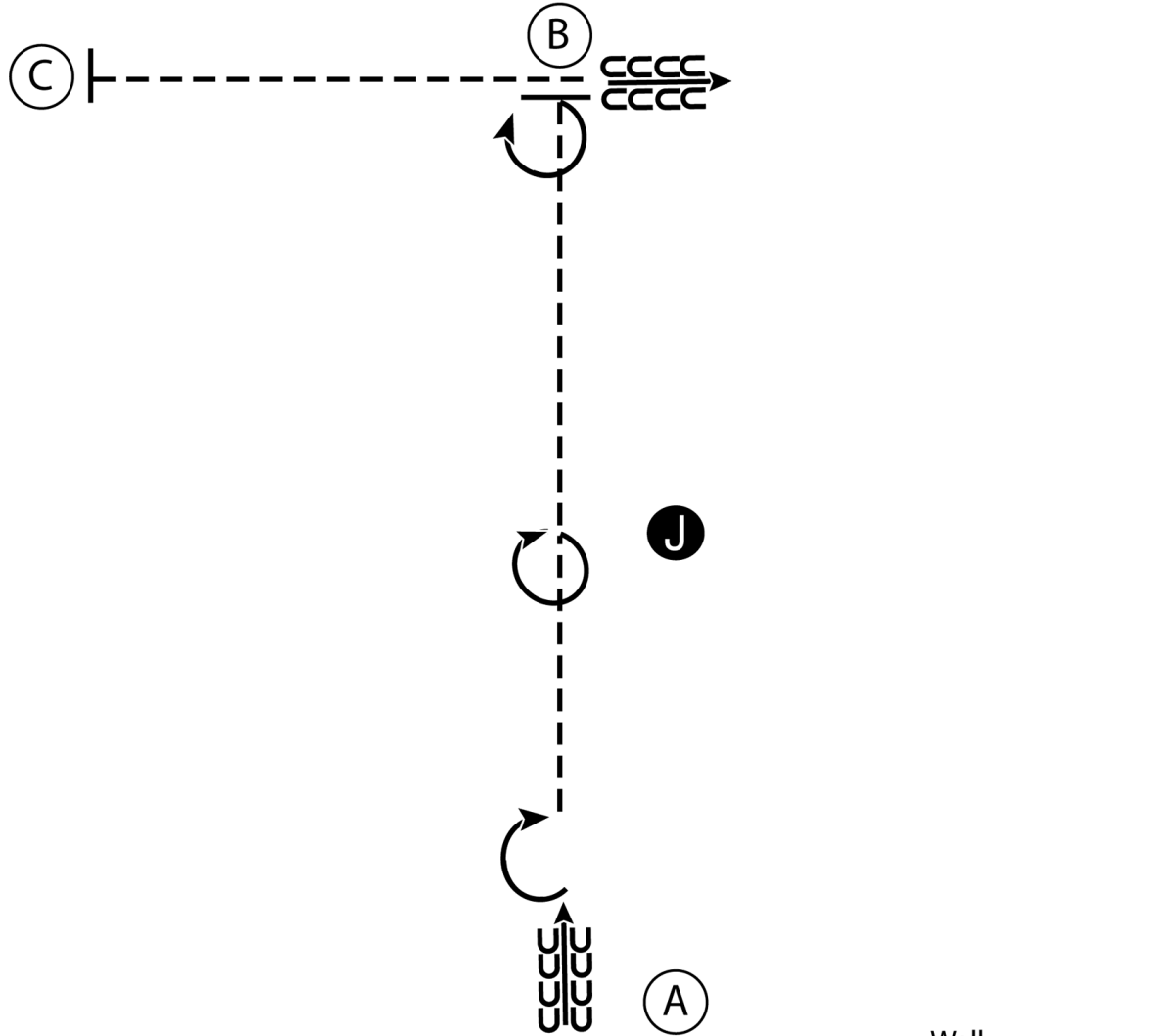

1. Begin facing away from the Judge. Back four steps.
2. Perform a 180 degree turn.
3. Trot to the Judge. Perform a 360 degree turn, stop and set up for inspection.
4. When dismissed trot to B.
5. Perform a 270 degree turn.
6. Back four steps and trot to C.
7. Stop and wait for instructions from the ring steward.

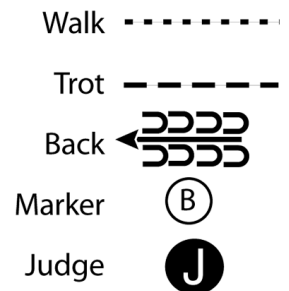

[S/3-12]

Pattern Provided by:

*HDPtHA*

# Mother's Day Pintofest

## Walk Trot/Novice Showmanship (All Walk Trot)

Show Date: 05-10-2015

w w w . H o r s e S h o w P a t t e r n s . c o m

w w w . H o r s e S h o w P a t t e r n s . c o m

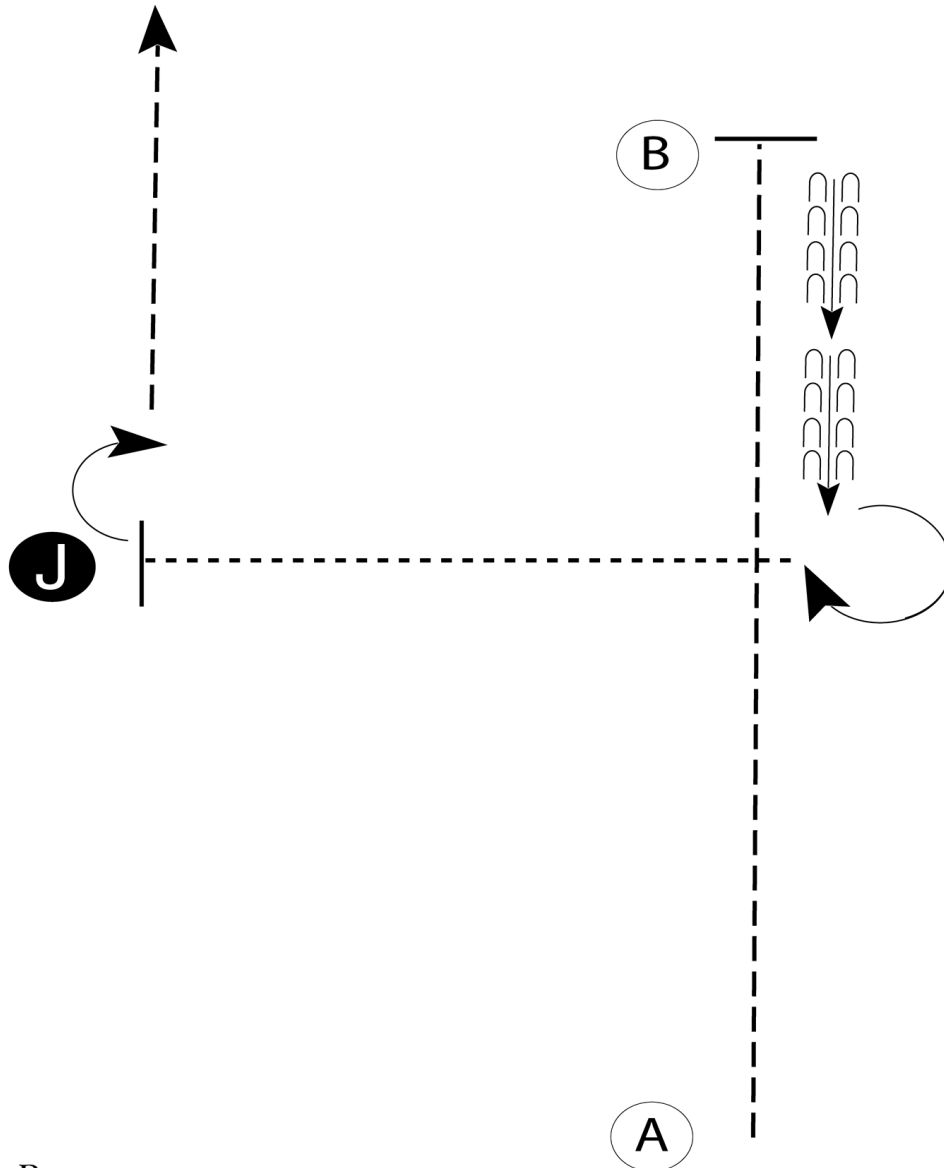

1. Trot A to B.
2. Stop at B.
3. Back halfway to A.
4. Perform a 270 degree turn .
5. Walk to the judge, stop and set up for inspection.
6. When dismissed, perform a 90 degree turn and trot away from judge.

Walk -----  
Trot -----  
Back -----  
Marker (B)  
Judge (J)

Follow the instructions of your ring steward.

[S/WT-1]

Pattern Provided by:

*HDPtHA*

# Mother's Day Pintofest

## Western Horsemanship Pinto (Open/Pinto Youth/Amateur)

Show Date: 05-10-2015

w w w . H o r s e S h o w P a t t e r n s . c o m

w w w . H o r s e S h o w P a t t e r n s . c o m

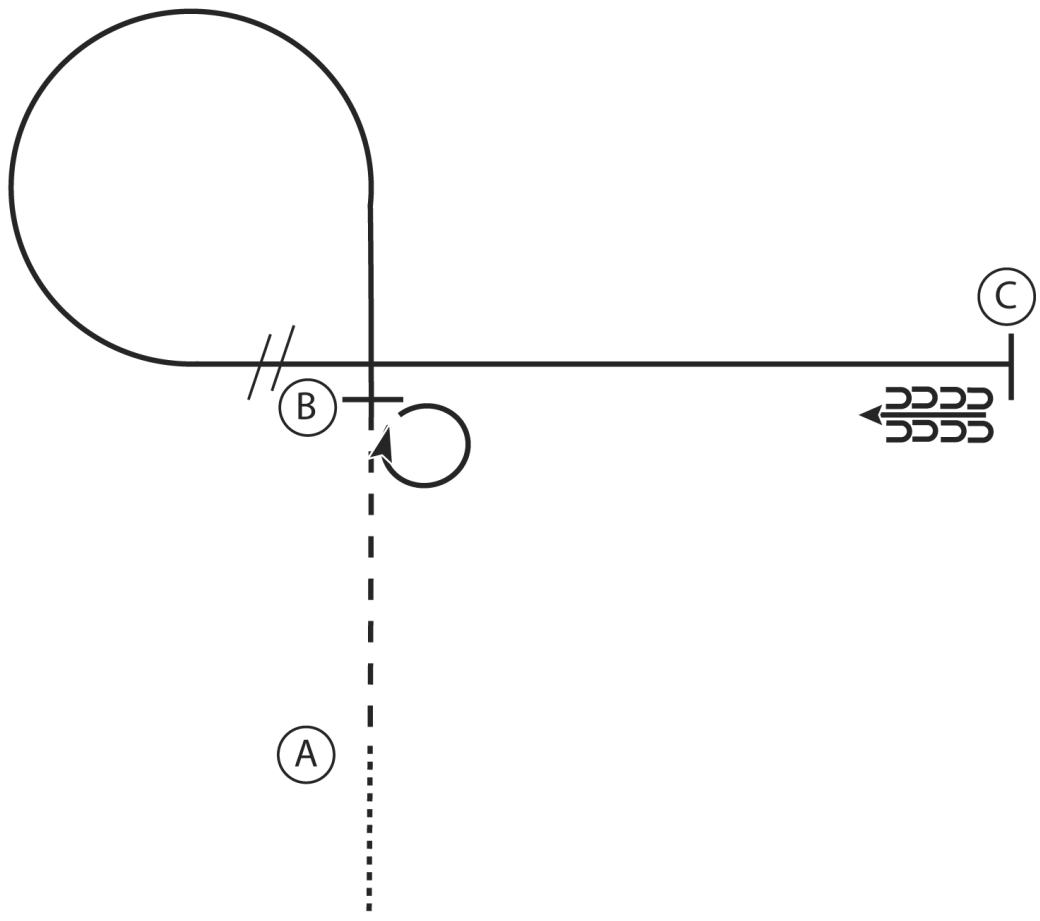

1. Walk to A
2. At A jog to B
3. Stop at B and perform a 360 degree turn to the right
4. Lope a circle to the left
5. At B perform a lead change and continue to C
6. At C stop and back 5 steps

Walk	.....
Jog	-----
Extended Jog	-----
Lope	—————
Leg Yield	
Lead Change	↘
Back	←←←←←
Marker	(B)
Sidepass	←---←

[WH/2-10]

Pattern Provided by:  
*HDPtHA*

# Mother's Day Pintofest

## Walk Trot/Novice Horsemanship (All Walk Trot)

Show Date: 05-10-2015

w w w . H o r s e S h o w P a t t e r n s . c o m

w w w . H o r s e S h o w P a t t e r n s . c o m

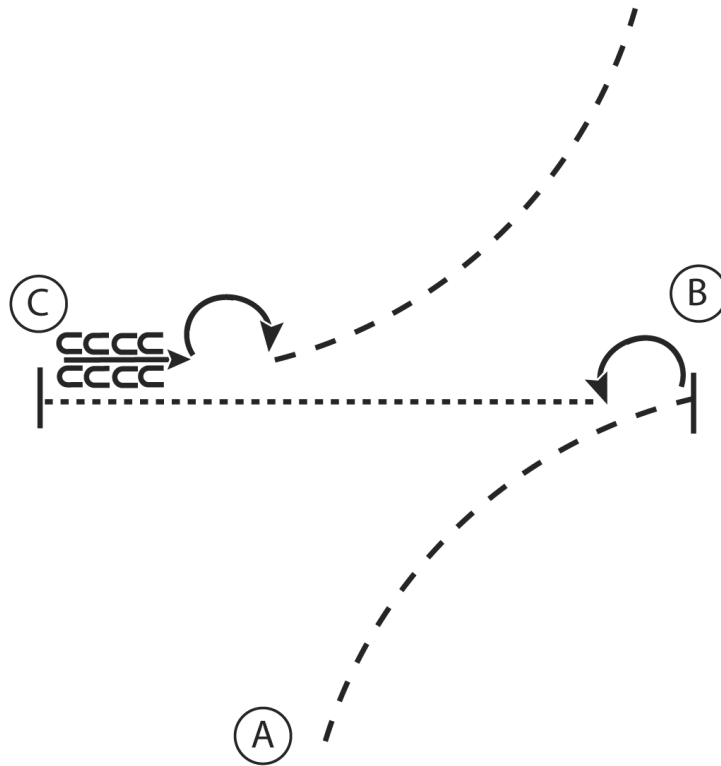

1. Jog a quarter circle from A to B
2. Stop at B and perform a 180 degree turn to the left on the hindquarters
3. Walk to C
4. At C stop and back 4 steps
5. Perform a 180 degree turn to the right
6. Jog a quarter circle to exit

Walk	.....
Jog	-----
Extended Jog	-----
Lope	—————
Leg Yield	
Lead Change	↙
Back	←←← ←←←
Marker	Ⓚ
Sidepass	←←←

[WH/WT-13]

Pattern Provided by:

*HDPtHA*